

天日乾燥床構造図 (1号)

1 - 1 断面図 S=1:200

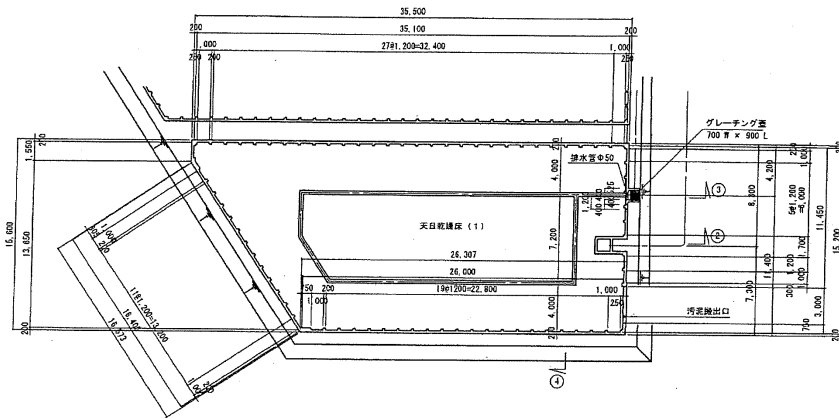

2 - 2 断面図 S=1:50

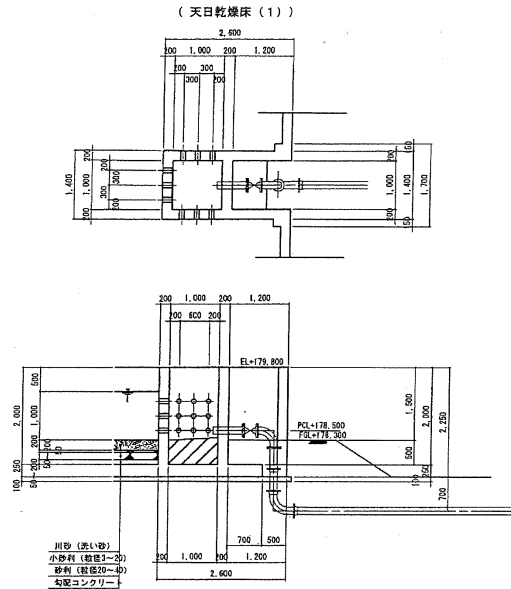

3 - 3 断面図 S=1:50

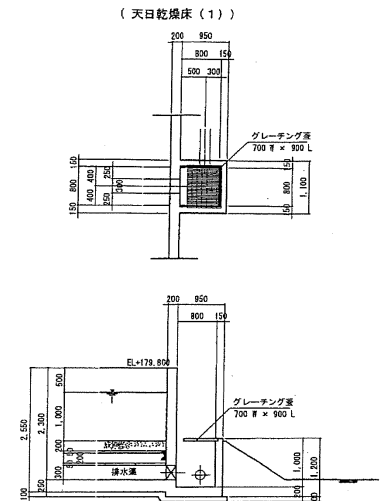

4 - 4 断面図 S=1:100

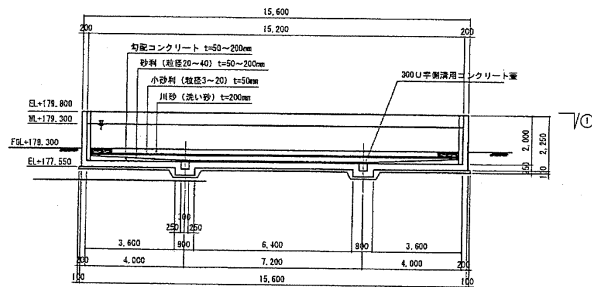

汚泥搬出口部断面図 S=1:50

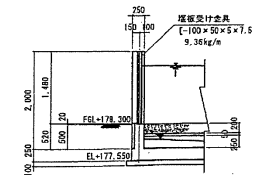

排水管展開図 S=1:50

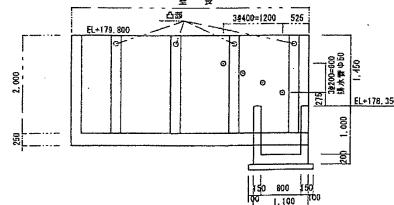

工事名	伊賀水道用水供給事業 ゆめが丘浄水場築造工事
施工箇所名	三重県伊賀市ゆめが丘
図面の種類	天日乾燥床構造図 (1号)
縮尺	図示 図面番号 331
事務所名	三重県伊賀水道建設事務所

天日乾燥床構造図 (2号~3号)

1-1 断面図 S=1:200

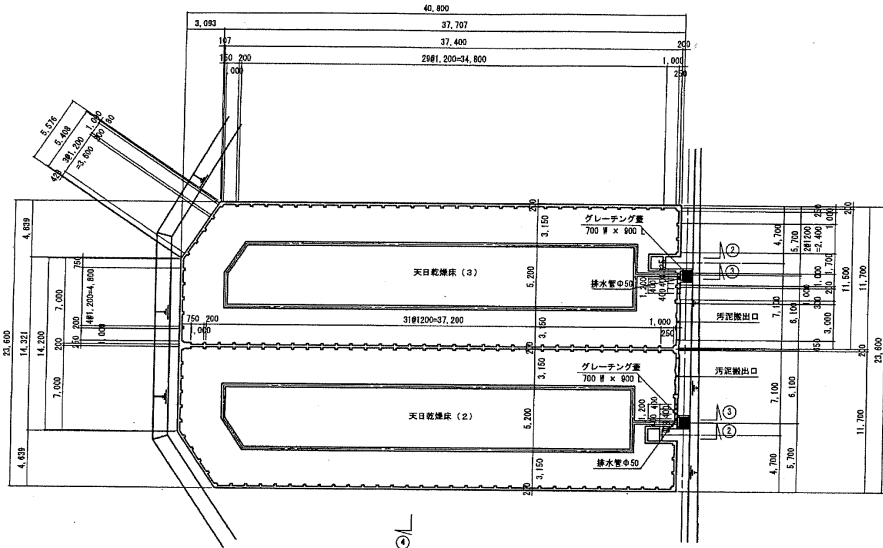

4-4 断面図 S=1:100

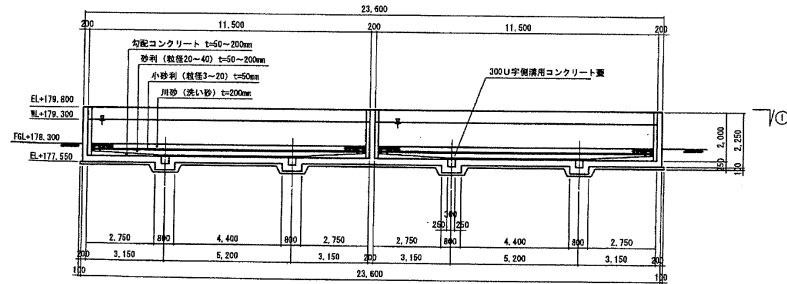

2-2 断面図 S=1:50

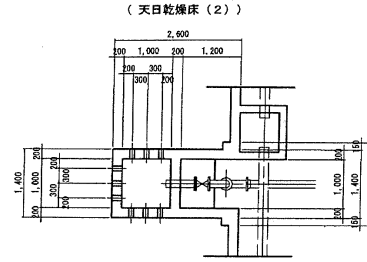

(天日乾燥床 (2))

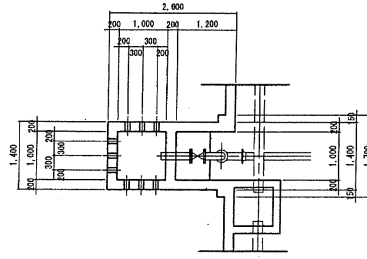

(天日乾燥床 (3))

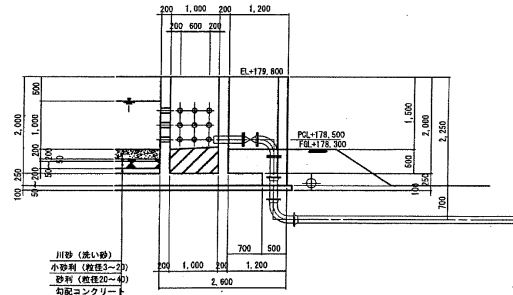

排水管展開図 S=1:50

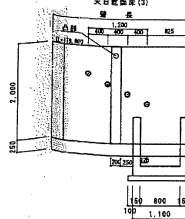

排水管展開図 S=1:50

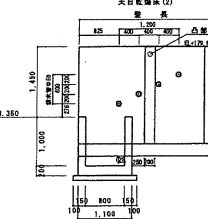

3-3 断面図 S=1:50

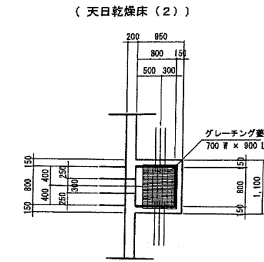

(天日乾燥床 (2))

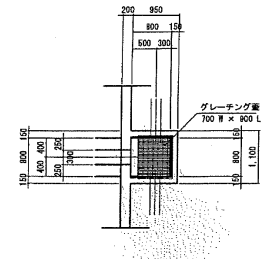

(天日乾燥床 (3))

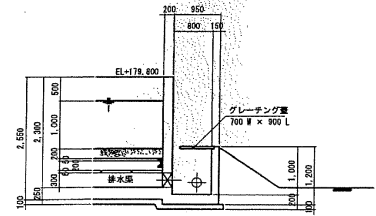

汚泥搬出口部断面図 S=1:50

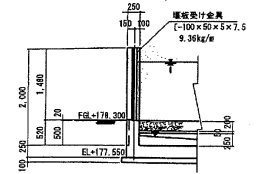

工事名	伊賀水道用水供給事業 ゆめが丘浄水場築造工事
施工箇所名	三重県伊賀市ゆめが丘
図面の種類	天日乾燥床構造図 (2号~3号)
縮尺	図示 図面番号 332
事務所名	三重県伊賀水道建設事務所

天日乾燥床構造図 (4号~5号)

1-1 断面図 S=1:200

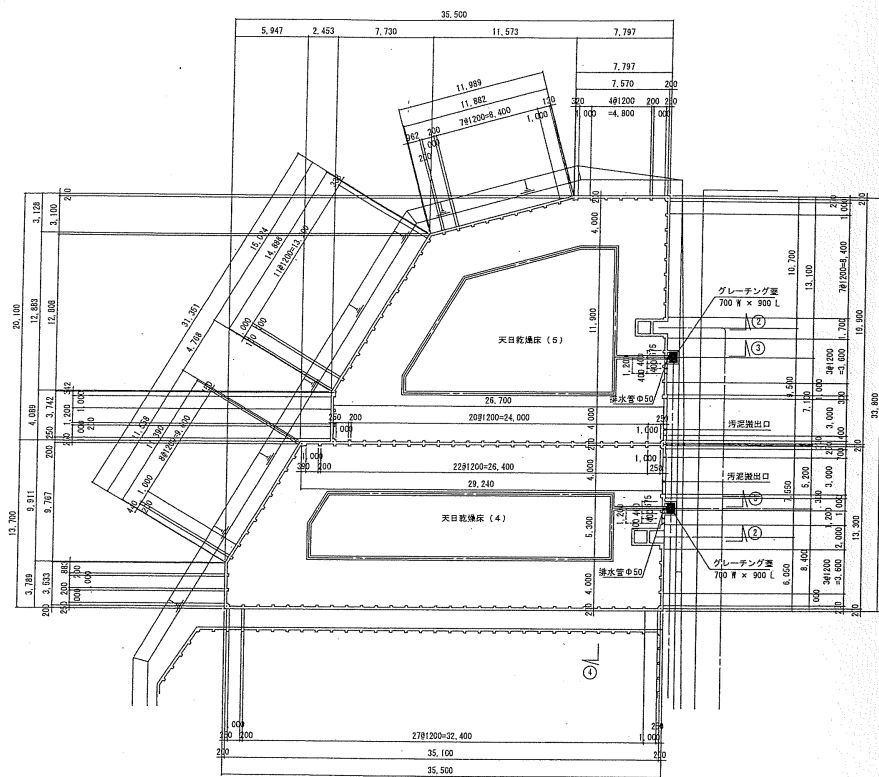

4-4 断面図 S=1:100

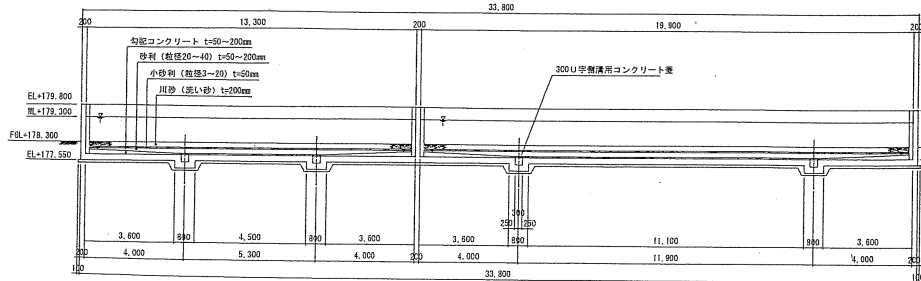

2-2 断面図 S=1:50

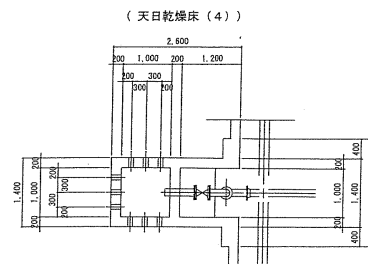

(天日乾燥床 (4))

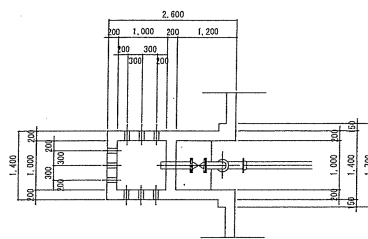

(天日乾燥床 (5))

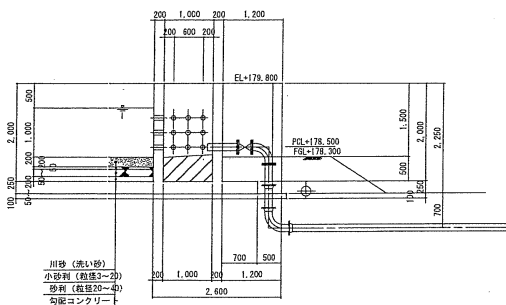

排水管展開図 S=1:50

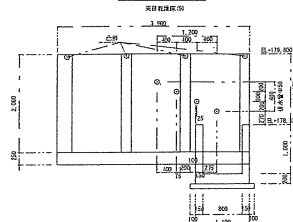

3-3 断面図 S=1:50

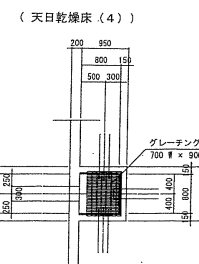

(天日乾燥床 (4))

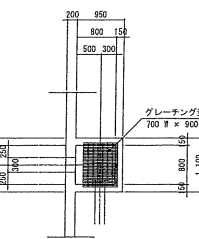

(天日乾燥床 (5))

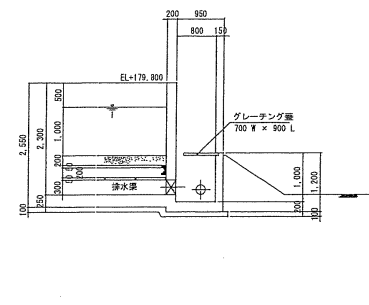

汚泥搬出口部断面図 S=1:50

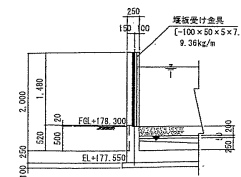

工事名	伊賀水道用供水事業 ゆめが丘浄水場築造工事
施工箇所名	三重県伊賀市ゆめが丘
図面の種類	天日乾燥床構造図 (4号~5号)
縮尺	図示 図面番号 333
事務所名	三重県伊賀水道建設事務所

天日乾燥床構造図 (6号~7号)

1 - 1 断面図 S=1:200

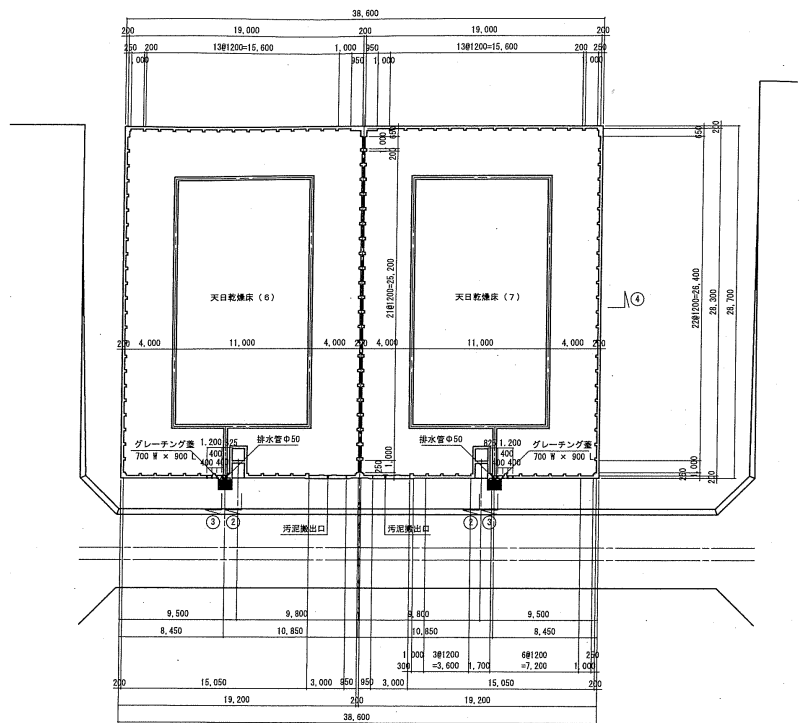

4 - 4 断面図 S=1:100

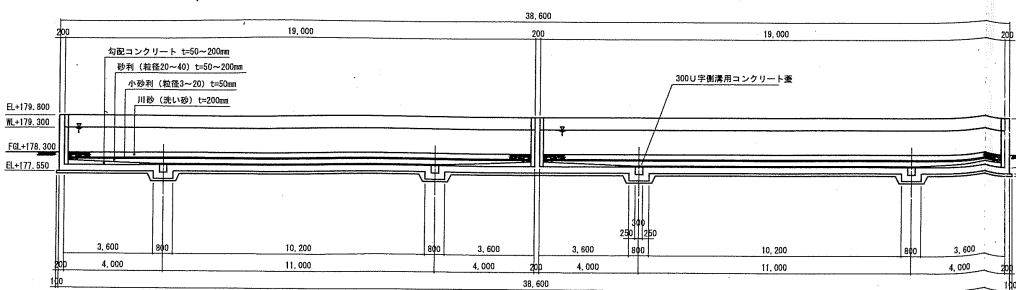

2 - 2 断面図 S=1:50

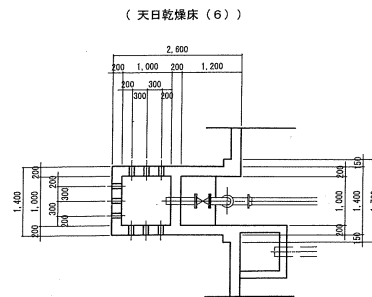

(天日乾燥床 (7))

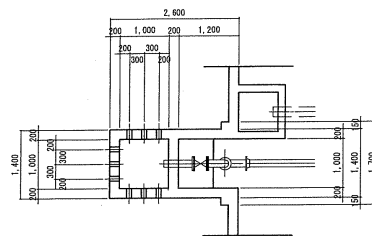

3 - 3 断面図 S=1:50

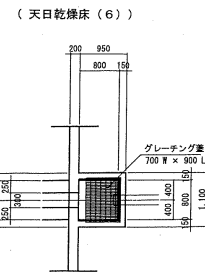

(天日乾燥床 (7))

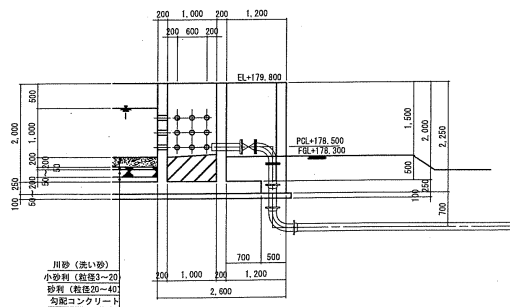
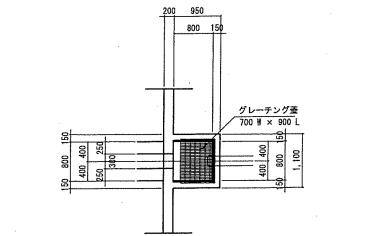

排水管展開図

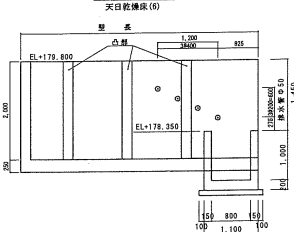

排水管展開図

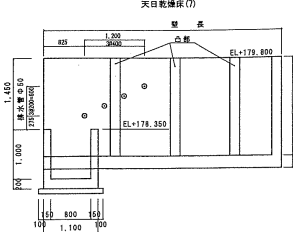

汚泥搬出口断面図 S=1:50

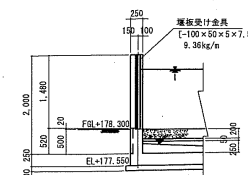

工事名	伊賀水道用水供給事業 ゆめが丘浄水場築造工事
施工箇所名	三重県伊賀市ゆめが丘
図面の種類	天日乾燥床構造図 (6号~7号)
縮尺	図示 図面番号 334
事務所名	三重県伊賀水道建設事務所

天日乾燥床構造図 (8号)

1 - 1 断面図 S=1:200

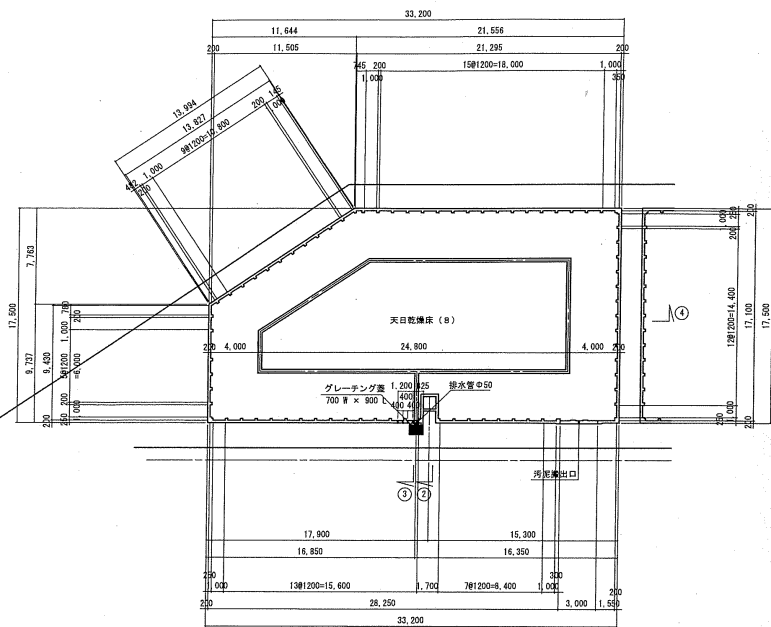

2 - 2 断面図 S=1:50

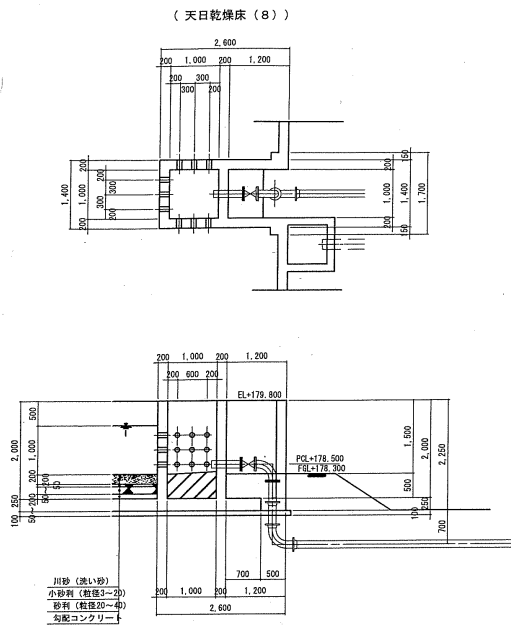

3 - 3 断面図 S=1:50

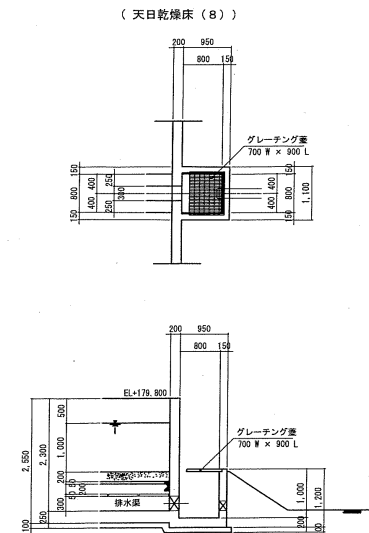

4 - 4 断面図 S=1:100

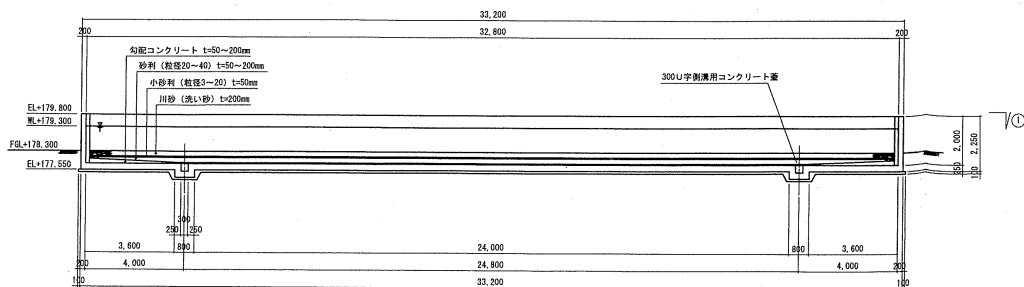

汚泥搬出口部断面図 S=1:50

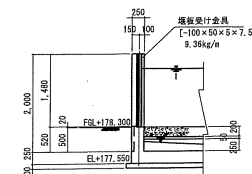

展開図

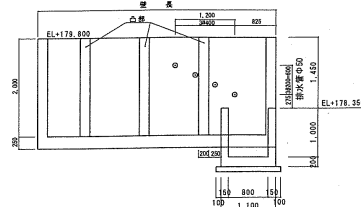

工事名	伊賀水道用水供給事業 ゆめが丘浄水場築造工事
施工箇所名	三重県伊賀市ゆめが丘
図面の種類	天日乾燥床構造図 (8号)
縮尺	図示 図面番号 335
事務所名	三重県伊賀水道建設事務所

天日乾燥床構造図 (9号~10号)

1 - 1 断面図 S=1:200

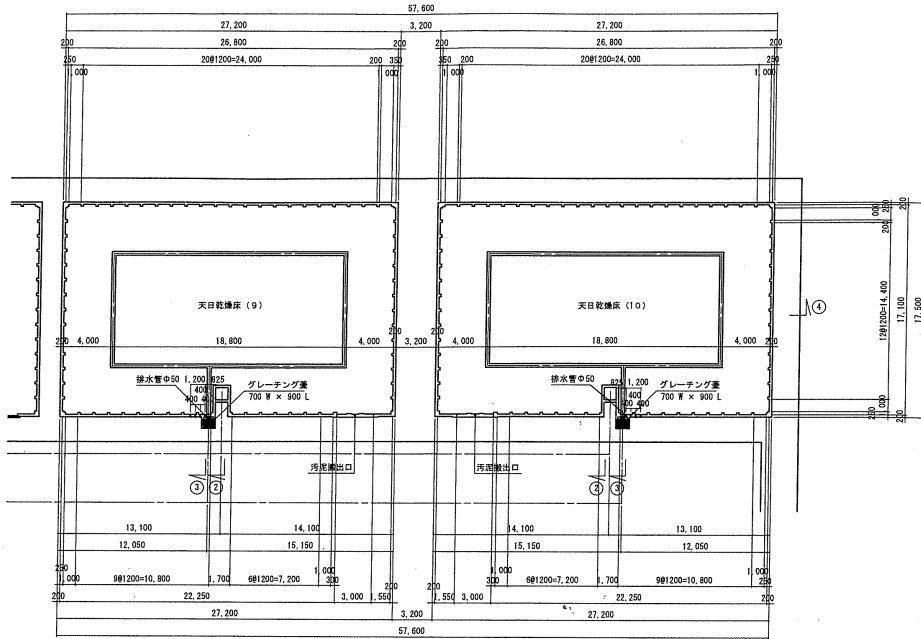

排水管展開図 S=1:50

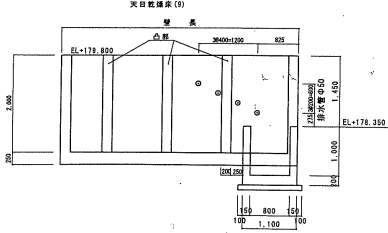

排水管展開図 S=1:50

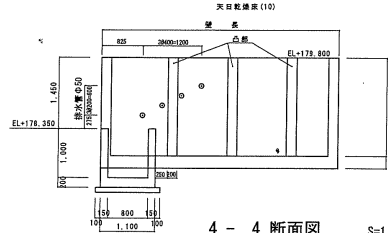

4 - 4 断面図 S=1:100

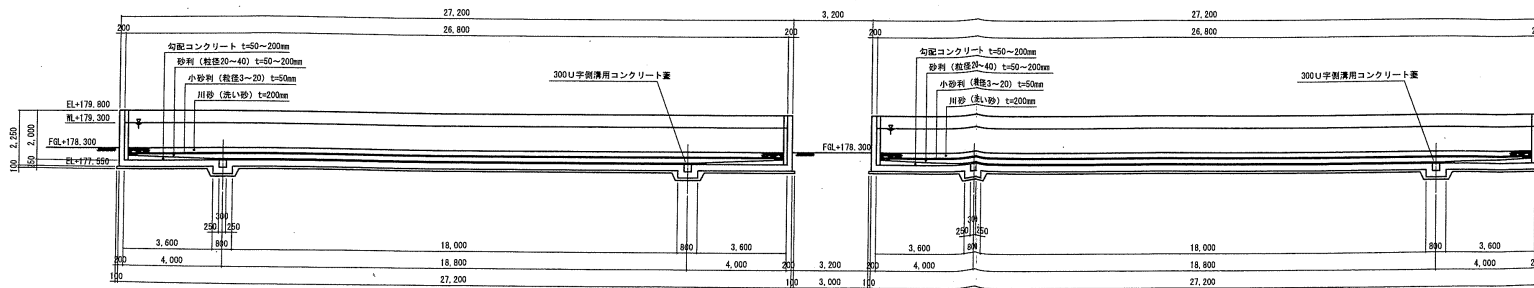

2 - 2 断面図 S=1:50

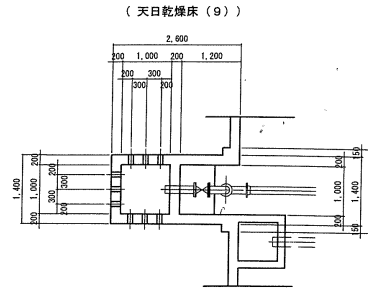

(天日乾燥床(10))

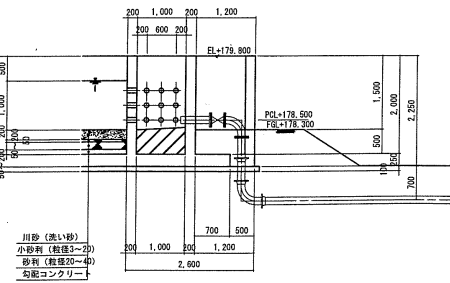
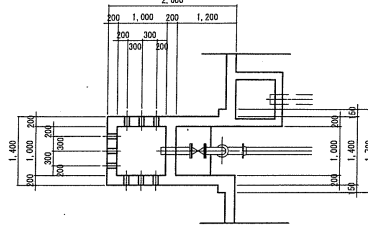

3 - 3 断面図 S=1:50

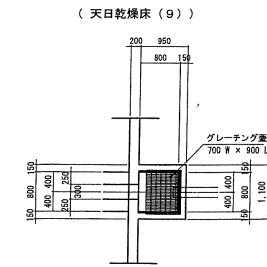

(天日乾燥床(10))

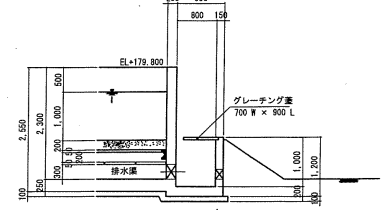
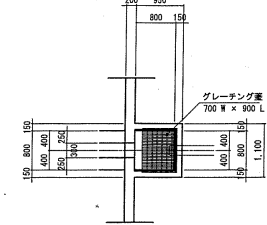

汚泥搬出口部断面図 S=1:50

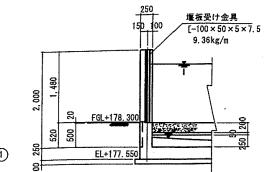

工事名	伊賀水道用水供給事業
	ゆめが丘浄水場築造工事
施工箇所名	三重県伊賀市ゆめが丘
図面の種類	天日乾燥床構造図 (9号~10号)
縮尺	図示 図面番号 336
事務所名	三重県伊賀水道建設事務所